



830802,830803

IP05 SERIES

**5:1 RATIO TRANSFER PUMP
OPERATIONS MANUAL**



IPM, INC.

Manufactured by International Pump Manufacturing, Inc.®

IP05 series

5:1 RATIO TRANSFER PUMP

OPERATIONS MANUAL and PARTS IDENTIFICATION DRAWINGS

This manual contains IMPORTANT WARNINGS and INSTRUCTIONS. Read and retain for future reference.

INTERNATIONAL PUMP MANUFACTURING, INC.

3107 142nd Avenue E Suite 106,

Sumner, WA 98390

U.S.A.

TEL: (253) 863 2222

FAX: (253) 863 2223

Website : www.ipmpumps.com

For Technical Service Call Your Local Distributor

Copyright 2014 by: International Pump Mfg, Inc.

WARNING: The equipment described herein must only be operated or serviced by properly trained individuals thoroughly familiar with the operating instructions, mechanics and limitations of the equipment.

Notice: All statements, information and data given herein are believed to be accurate and reliable but are presented without guarantee, warranty or responsibility of any kind expressed or implied. Statements or suggestions concerning possible use of IPM equipment are made without representation or warranty that any such use is free of patent infringement, and are not recommendations to infringe any patent. The user should not assume that all safety measures are indicated or that other measures may not be required.

TABLE OF CONTENTS

1.0 SAFETY WARNINGS	4
1.1 Procedure for pressure relief	5
1.2 Pump & component grounding	6
2.0 INSTALLATION	8
2.1 Installation procedures	8
2.2 Additional mounting configurations	9
3.0 OPERATIONS	11
4.0 PARTS IDENTIFICATION	12
4.1 Parts drawing/parts list for 830802 (Air section)	12
4.2 Parts drawing/parts list for 830802 (Fluid section)	13
4.3 Parts drawing/parts list for 830803 (Air section)	14
4.4 Parts drawing/parts list for 830803 (Fluid section)	15
5.0 REPAIR KITS	16
6.0 TROUBLESHOOTING	17
7.0 TECHNICAL SPECIFICATIONS	18
8.0 WARRANTY & DISCLAIMER	21

1.0 SAFETY WARNINGS

Please read and observe all warnings contained in this operations manual before making any attempt to operate the equipment.

Warning

To reduce the risk of static sparking or splashing fluid in the eyes or on the skin, follow the ***pressure relief procedure*** before flushing.

For your safety, read the ***fire or explosion hazard*** before flushing and follow all the listed recommendations.

Misuse of equipment

Misuse of equipment can cause serious bodily injury. Use the equipment only for its intended purpose and do not attempt to modify it in any way. Care should be taken to prevent over pressurization of the pump, hose lines and accessories connected to it. Use only IPM designated parts for re-building or repairing this equipment. Use the pump only with compatible fluids. Improper use of this equipment could result in fluid being sprayed on the skin or in the eyes of user, serious bodily injury, property damage, fire or explosion.

Daily maintenance inspection should be made on pumps and equipment and all worn or damaged parts should be re-placed immediately. Do not use pumps, components or hose lines as leverage to move equipment to avoid damage and injury.

Do not alter this equipment as doing so could cause it to function incorrectly and/or cause serious injury. Altering this equipment in any way will also void any and all warranty guarantees from the manufacturer.

Material & fluid compatibility

Always ensure the chemical compatibility of the fluids and solvents used in the fluid section of these pumps, hoses other components. Check the chemical manufacturer's data sheets and specification charts before using fluids or solvents in this pump to ensure compatibility with pumps, inner hose lining and outer hose covering.

Pressurized hoses

Because the hoses are pressurized they can present a danger should the fluid escape due to damage, worn parts or general miss-use. Escaping fluid can splash or spray operator, causing serious bodily injury and/or damage to equipment and property. Ensure that the hoses do not leak or rupture due to wear, misuse or damage.

Before each use, ensure that the fluid couplings are tight and all clips/pins/plugs are secured. Inspect the entire length of hose for wear, cuts, abrasions, bulging cover and/or loose connections. These conditions may cause the hose to fail and result in splashing or spraying of chemicals on the skin or in the eyes of operator and cause serious injury and/or property damage.

Pressure specification

The maximum working pressure of this equipment for fluids and air is **1160 PSI (125 bars)** with a maximum incoming air pressure tolerance of **180 PSI (12.5 bars)**. Ensure all equipment and accessories used with this pump are rated to withstand the maximum working pressure of this pump. Never exceed the maximum working pressure of the pump, hose lines or any other components attached to the pump itself.

Pressure relief procedure

In order to avoid the risk of serious bodily injury such as: splashing fluid on the skin, in the eyes, or injury from moving parts- the following procedure should be used. This procedure should be used when: shutting down the pump, servicing or repairing the pump or any part of the system, replacing or cleaning components, and/or when fluid ceased pumping.

1. Close the air valve to the pump.
2. Use the air bleed down valve (see installation instructions) to relieve the air pressure in the system.
3. Relieve the fluid pressure by holding a grounded metal pail in contact with the metal part of the fluid dispensing valve and slowly open the valve.
4. With a container ready to catch the fluid, open the drain valve (see installation instructions).
5. It is a good practice to leave the drain valve open until it is time to dispense fluid again.

If you are unsure that the fluid pressure has been relieved (due to a blockage in a component or a hose) be careful to relieve the pressure by slowly loosening the hose end coupling to allow the fluid pressure to escape slowly. After the pressure has been relieved, the fitting can be removed completely and any blockages removed.

Flush the pump before initiating operation

1. The pump is tested with lightweight DOP oil, which is left in to protect the pump parts. If the fluid you are pumping may become contaminated by oil, flush oil from pump with a compatible solvent before use. Follow the flushing instruction below.
2. When pumping fluids that set up or solidify, flush the system with a compatible solvent as often as necessary to remove build-up of solidified chemicals in the pump or hoses.
3. If the pump is being used to supply a circulating system, allow the solvent to circulate through the entire system for at least 30 minutes every 48 hours or more often if necessary to prevent settling and solidification of chemicals.
4. Always fill the wet-cup 1/2 full of throat seal liquid (TSL) or compatible solvent to keep the fluid from drying on the displacement rod and damaging pump throat packing.
5. Lubricate the throat packing frequently, when you are pumping a non-lubricating fluid or are shutting down for more than one day.

6. IPM transfer pumps incorporates a wet tube, the purpose of which is to prevent the build-up of chemical and dirt on the pump shaft which would damage the packing as the shaft reciprocates through them. This wet tube must be full when a pump that has not been thoroughly flushed and cleaned is stored outside the protected environment of a sealed drum as well as when the pump is in use. Should a pump be installed in a partially filled drum where the liquid level is below the top of the wet tube, the tube must be manually filled with the proper chemical prior to inserting into the drum.
7. Once a pump is committed to a particular chemical, it is good practice to identify which chemical a particular pump is designated for to eliminate the possibility of mix up and contamination.

Lubrication

Transfer pump should be lubricated daily. Drain moisture from the air regulator. To manually lubricate the motor, disconnect the air lines at the motor and place approximately 10 of oil in the **air inlet**. Reconnect the air line and turn on the air to blow oil into the motor. Also keep the wet-cup filled with Throat Seal Liquid (TSL) or compatible solvent. This will reduce maintenance and prolong the packing life. Adjust the packing nut weekly so it is just tight enough to prevent leakage but do not over-tighten as this will restrict pump operation.

Shut down & care of pump

For overnight shut down, follow the pressure relief procedure (page 5). **Always stop the pump at bottom of the stroke to prevent the fluid from drying on the exposed displacement rod and damaging the throat packing.**

Hazards from Fire or Explosion

Hazards exist where sparks can ignite vapors or fumes from combustible chemicals or other hazardous conditions exist such as explosive dust, etc. These sparks can be created from plugging in or unplugging an electrical supply cord or from the static electricity generated by the flow of fluid through the pump and hose.

Every part of the equipment must be properly grounded to prevent static electricity from generating a spark and causing the pump or system to become hazardous. These sparks can cause a fire, explosion, property and equipment damage and serious bodily injury. Ensure that the pump and all components and accessories are properly grounded and that electrical supply cords are not plugged in or unplugged when these hazards exist.

Should any evidence of sparks or static electricity exist, discontinue pump operation immediately. Investigate the source of the static electricity and correct the grounding problem. Do not use the system until the grounding problem is repaired.

1.1 Pump and component grounding procedures

Always use the following procedures for grounding the pump. Loosen the lock screw to allow insertion of one end of a minimum sized 12 gauge wire into the bore hole of the grounding lug.

Insert wire and tighten the lock screw securely. Secure the other end of the ground to a true earth ground. Grounding of the pump and all components is necessary to minimize the possibility of sparks due to static electricity. Grounding must be in compliance with local electrical codes. Check with the local authorities for requirements in your area and with the type of equipment being used.

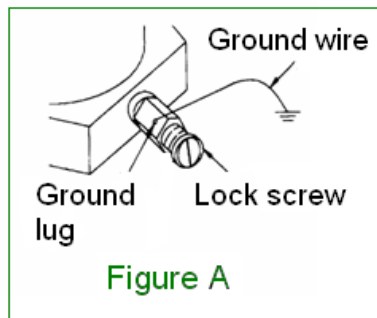

Grounding of the pump and all other dispensing equipment is necessary to minimize the possibility of sparks due to static electricity. Grounding must be in compliance with local electrical codes. Check with local authorities for requirements in your area and with the type of equipment being used. Ensure that all the following equipment is grounded:

1. Air Compressor: Follow the grounding procedures as recommended by the manufacturer.
2. Air Hoses: Use grounded air hoses.
3. Fluid Container used to supply the system: Grounding must be done according to local codes.
4. Pump: Follow the procedures included referring to Figure 1.
5. Fluid Hoses: Use grounded fluid hoses.
6. Dispensing Valve: The valve must be metal to conduct through the fluid hose to the pump which must also be properly grounded.
7. Dispensing Point: Grounding must be done according to local codes.
8. Solvent Containers: Grounding must be done according to local codes. Use conductive metal pails that are properly grounded.
9. Dispensing, cleaning or pressure release: Maintain conductivity by firmly holding metal part of dispensing valve to the side of grounded container.

Hose Grounding

It is very important that the hoses used for both air and fluid be of a grounding type and that the ground continuity is maintained. Regular checks of the hose's ground resistance with a resistance meter using a suitable range and a comparison to the manufacturer's specification will ensure the ground is within specifications. If it is not within specified limits it should be replaced immediately.

Solvent Cleaning

When cleaning the system with solvent, hold the metal part of the dispensing valve in contact with a grounded metal pail to minimize the possibility of splashing fluid on the skin or in the eyes or static sparks. Use low fluid pressure for additional safety.

Hazards From Moving Parts

Use the **Pressure Relief Procedure** page 5 to prevent the pump from starting unintentionally when not desired. Take care that moving parts present a pinching hazard to fingers or other body parts. Stay clear of these moving parts when starting or operating the pump. Never operate the pump with the air motor plates removed.

Safety Standards

Safety standards have been established by the United States Government under the Occupational Safety and Health Act. These standards should be consulted as they apply to the various hazards and differing types of equipment being used.

2.0 INSTALLATION

2.1 Typical wall mount pump configuration

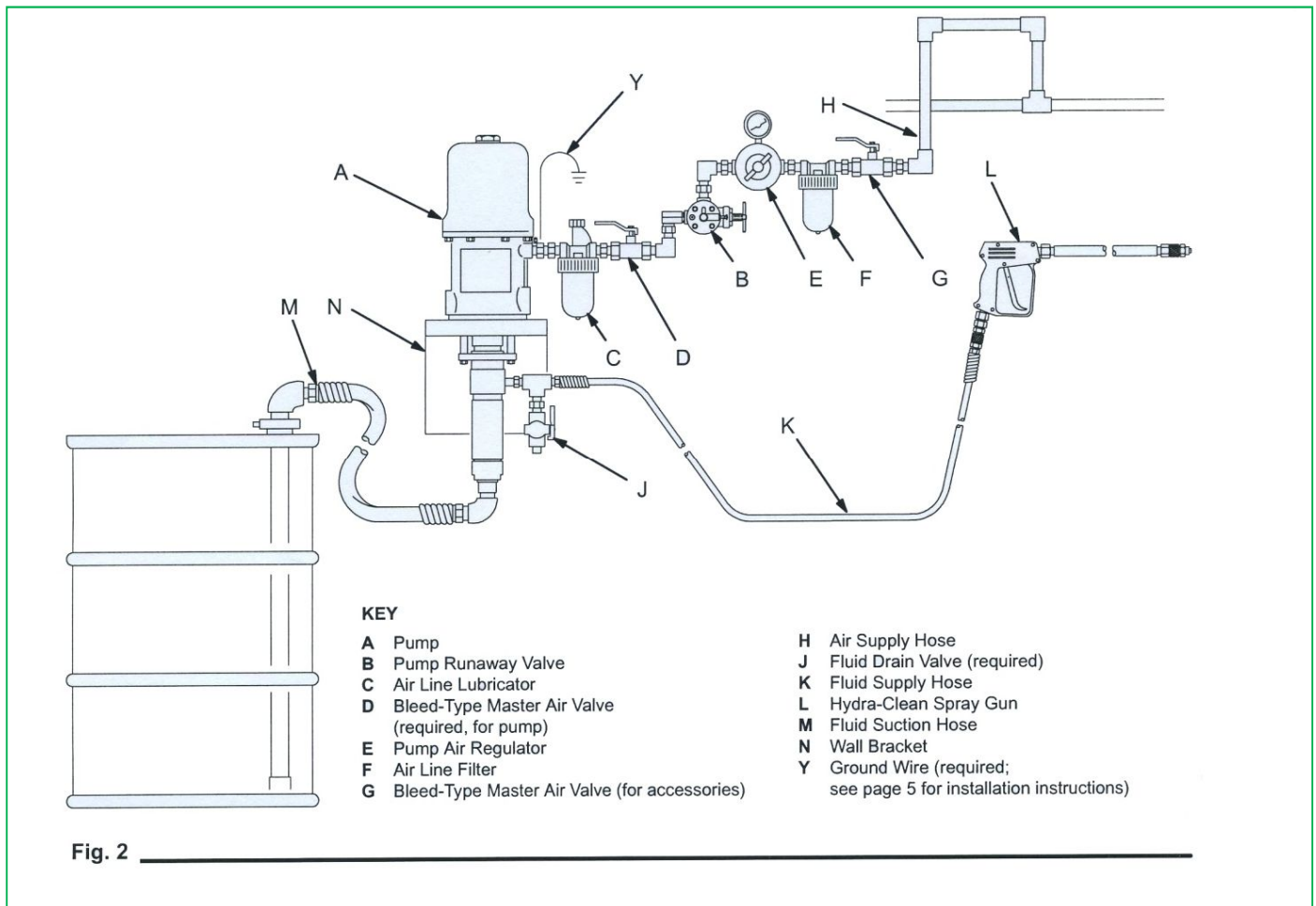
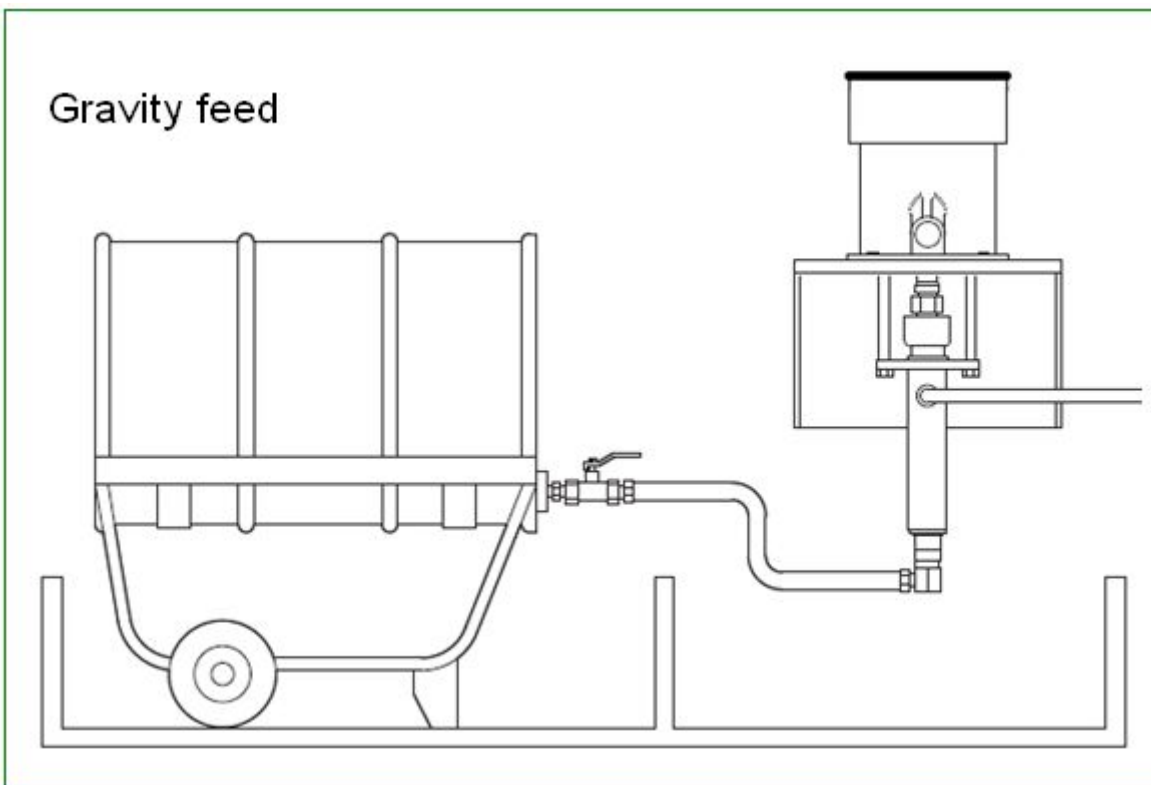
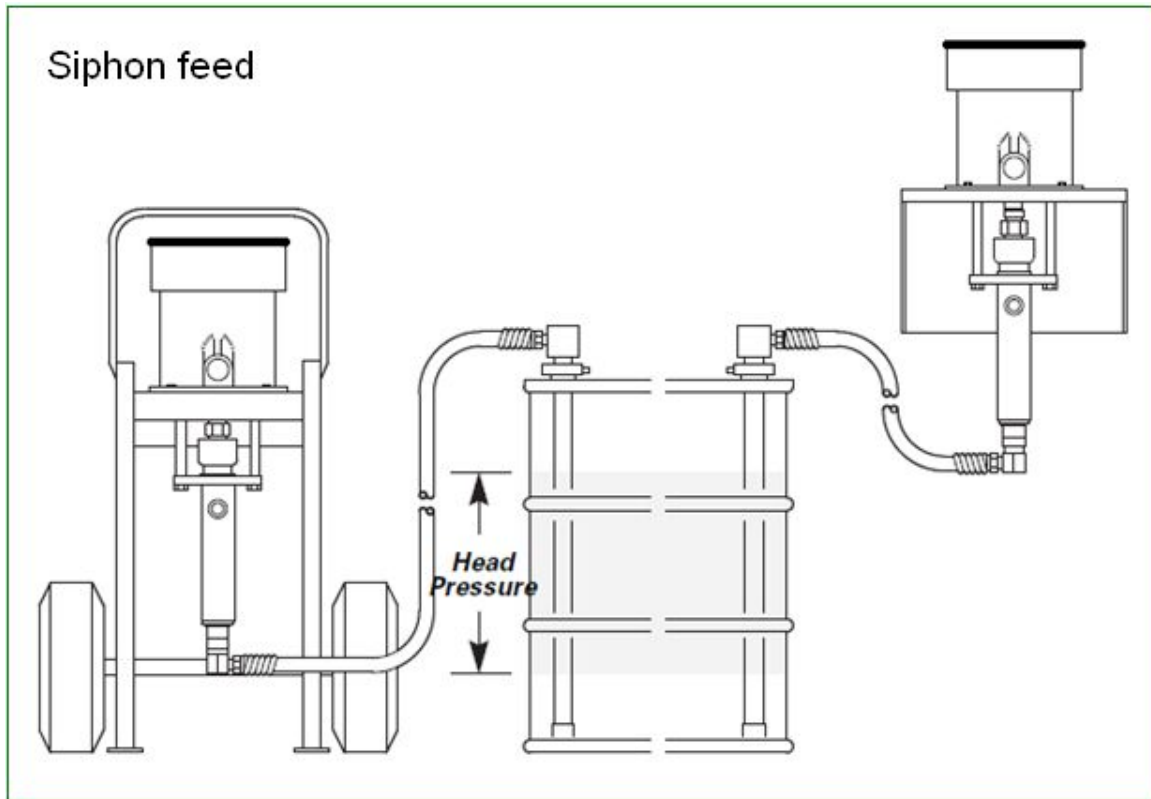

Figure 2 depicts a typical wall mount installation with various options and accessories for added safety, efficiency and maintenance concerns. Drum version and wall mount units are both available in the IP05 series pumps.

2.2 Additional mounting configurations



3.0 OPERATIONS

Start up and Adjustment of the Pump

1. Using figure 2 (page 9) as a reference, shut off main air supply, master air valve and fluid drain valve. ***Do not install the spray tip yet.***
2. Insert suction tube into the fluid supply drum for wall mount set-up or the pump itself for drum length unit.
3. Hold the spray gun firmly to the side of the supply drum and hold the trigger open.
4. Carefully open the pump's bleed-type master air valve.
5. Slowly open the main air supply until the pump starts cycling, which will be at about 40 PSI (2.8 bar).
6. Cycle the pump slowly until all the air is purged to ensure the pump and hoses are fully primed.
7. Release the spray gun trigger and lock the safety. The pump should completely stall under pressure when the trigger is released.
8. With the pump and lines primed and adequate air pressure and volume supplied the pump will start and stop as the spray gun is opened and closed.
9. To relieve the pressure, follow the pressure relief procedure (page 5), then install the tip guard and spray tip in the gun.
10. For optimum efficiency, use an adequately sized air regulator to control the pump speed and fluid pressure. Always used the lowest air pressure necessary to get desired results. Higher pressures waste fluid, create erratic spray patterns and cause premature wear of the pump packings and nozzles.
11. Into a grounded metal container, slowly open the dispensing valve. Ensure metal-to-metal contact between the container and the valve.

Note: *The pump should never be allowed to run dry of fluid. When drum runs empty the pump speed will increase dramatically and equipment damage will occur. During operation, should the pump be found running too fast stop it immediately and check the fluid supply. If air has gotten into the system, a priming procedure should be done. Ensure that all air has been expelled from the lines before resuming normal operations. Flush the pump or leave it filled with a suitable solvent when not in use. Always follow the pressure relief procedure (page 5) should the pump be put away for any period of time or during system shut off at the end of the day.*

4.0 PARTS IDENTIFICATION

4.1 Parts drawing for air motor section Pump # 830802

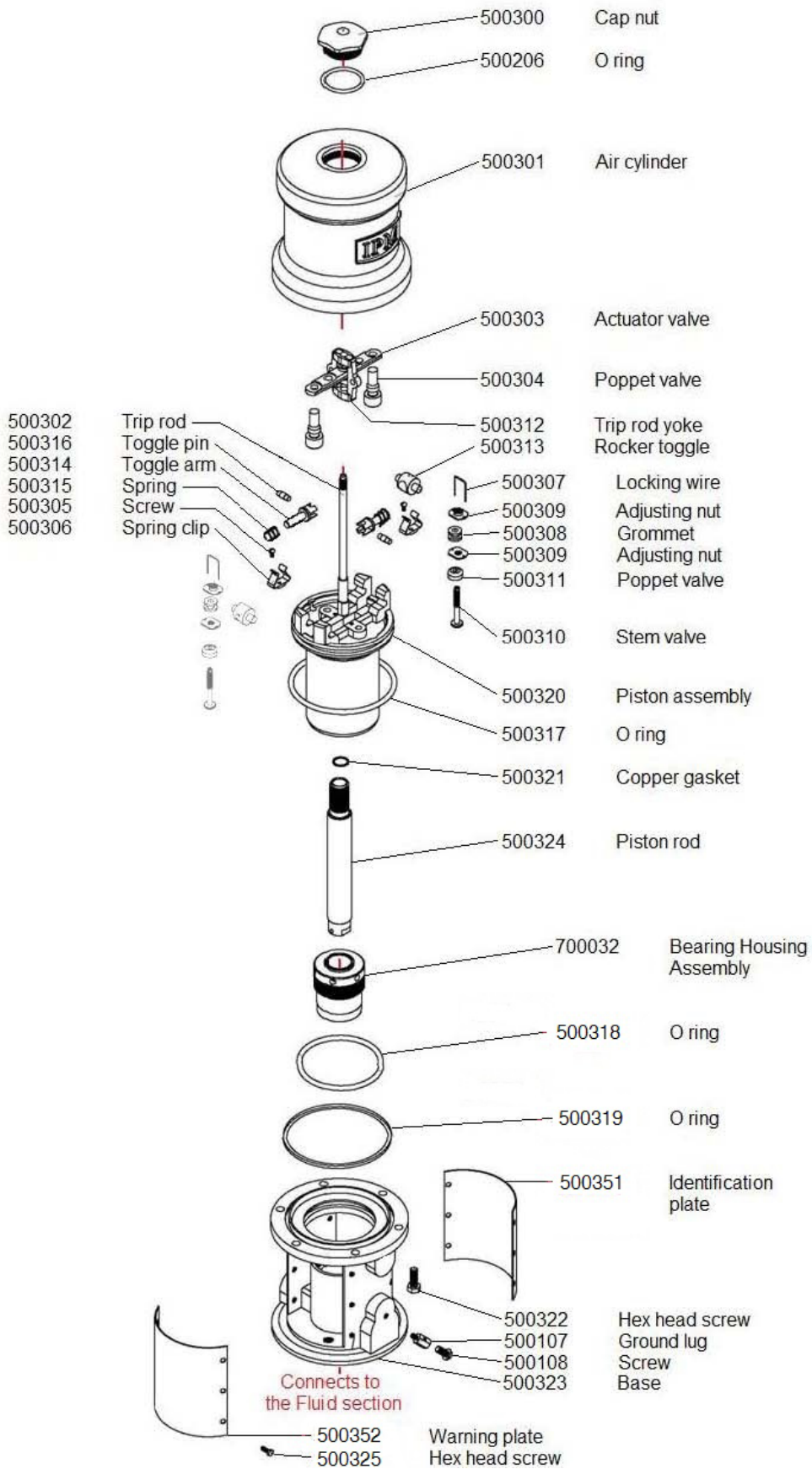

4.2 Parts drawing for fluid section Pump # 830802

Connects to
the Air section

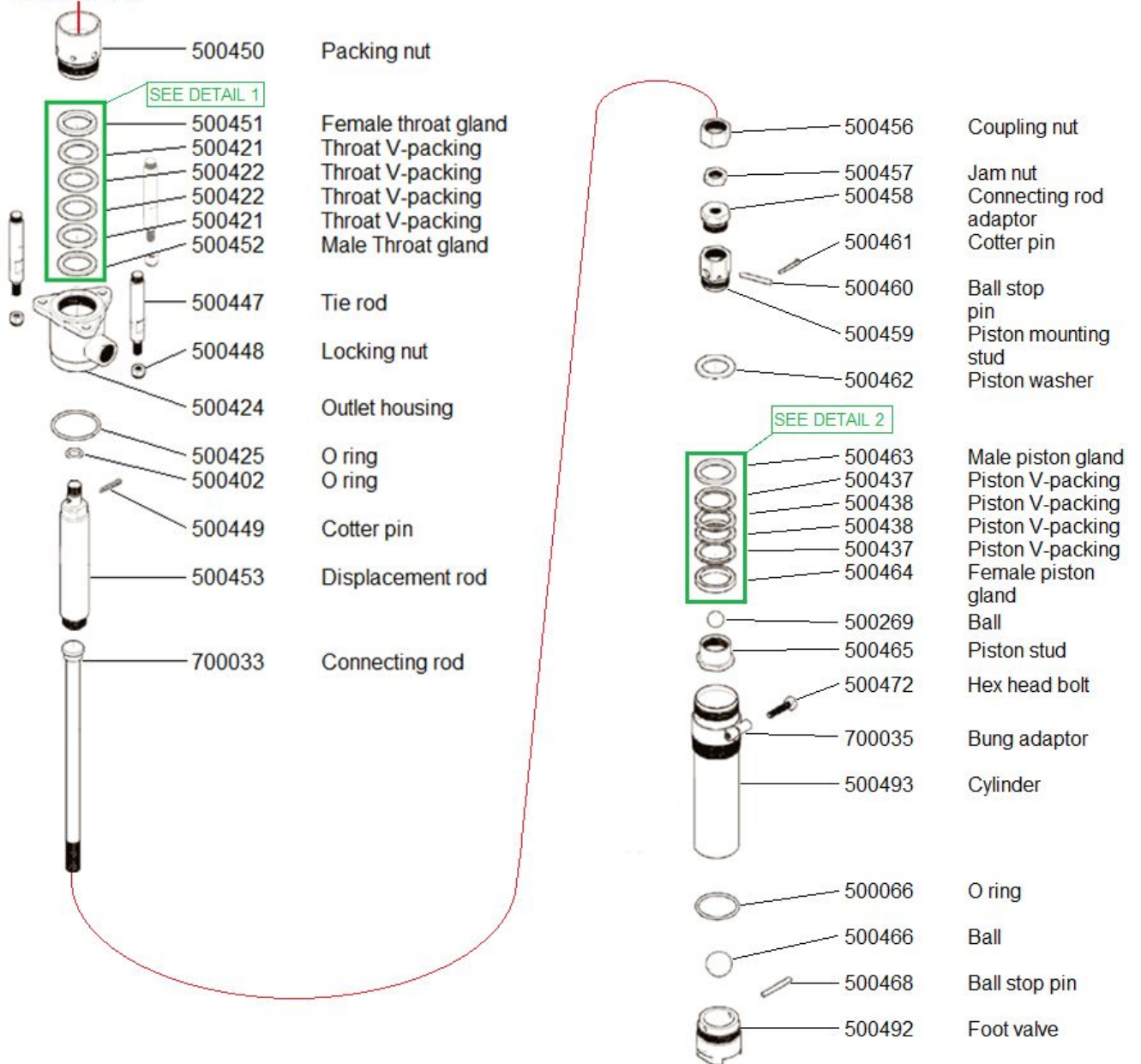

DETAIL 1

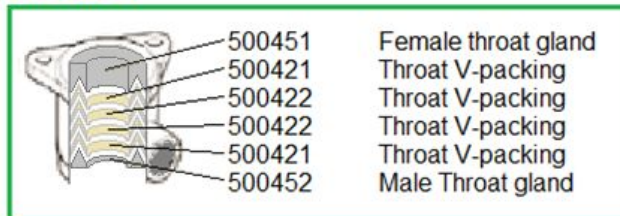

DETAIL 2

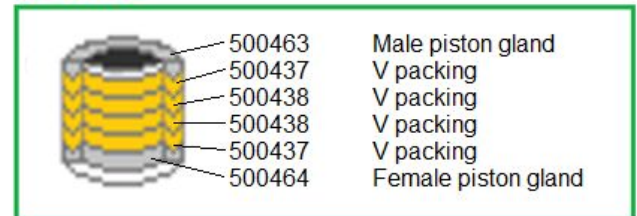

4.3 Parts drawing for air motor section Pump # 830803

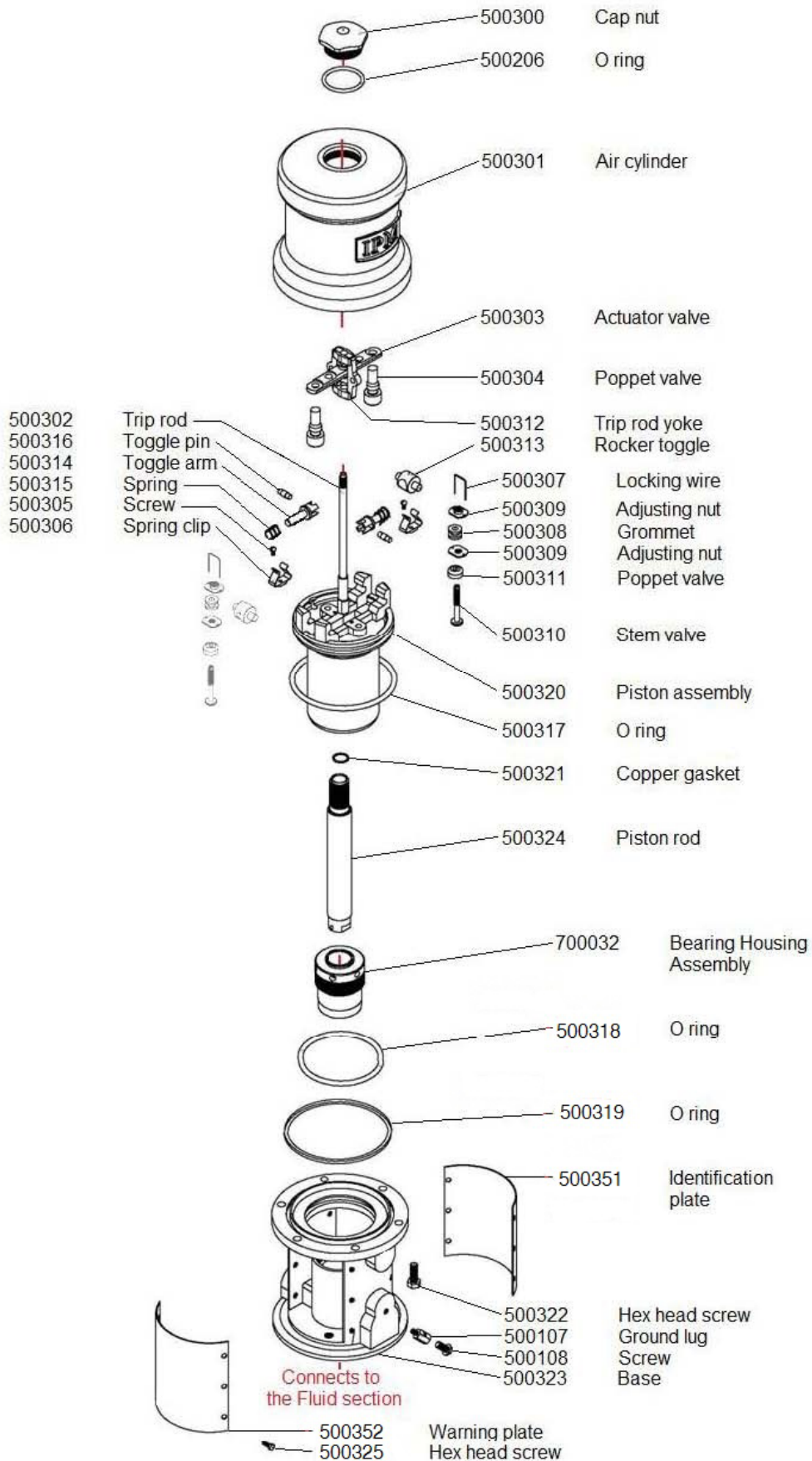

5.0 REPAIR KITS

IP05 series – 5:1 pump repair kits

601001	Air section repair kit		
	Fits: 830802, 830803		
	Components include		
	Part #	Description	Qty
	500304	Poppet valve	2
	500307	Locking wire	2
	500308	Grommet	2
	500309	Adjusting nut	4
	500310	Stem valve	2
	500311	Poppet valve	2
	500317	O-ring	1
500318	O-ring	1	

601020	Fluid section repair kit		
	Fits: 830802, 830803, 840902, 840903		
	Components include		
	Part #	Description	Qty
	500269	Ball, SS	1
	500402	O-ring	1
	500421	"V" packing	2
	500422	"V" packing	2
	500425	O-ring	1
	500437	Piston "V" packing	2
	500438	Piston "V" packing	2
	500449	Cotter pin	1
	500451	Female gland	1
	500452	Male gland	1
	500460	Ball stop pin	1
	500461	Cotter pin	2
	500462	Piston washer	1
	500463	Male piston gland	1
	500464	Female piston gland	1
500466	Ball, SS	1	
500468	Ball stop pin	1	
500066	O-ring	1	

6.0 TROUBLESHOOTING

Problem	Causes	Recommended Solutions
Pump does not operate.	Air supply or pressure is inadequate. Air lines restricted.	Increase air pressure. Check for any restrictions in air line.
	Dispensing valve is not open or clogged.	Open and/or clear foot valve.
	Clogged fluid lines, valves, hoses or damaged air motor.	Follow pressure relief procedure to clear obstruction. Service air motor. Replace parts as necessary.
	Depleted or exhausted fluid supply.	Refill fluid. Prime system or flush it.
	Worn or damaged air motor gasket, packing, seal, etc	Service air motor. Replace parts as necessary.
Non-stop air exhaust.	Intake valve or packing worn off.	Replace worn parts
Erratic pump operation.	Intake valve is not completely closed.	Clear obstruction and service pump. Replace parts as necessary.
	Held open or worn intake valve.	Clear obstruction and service pump. Replace parts as necessary.
Low output on upstroke.	Held open or worn piston valve.	Clear obstruction and service pump. Replace parts as necessary.
Low output on down stroke.	Restriction in air lines or air pressure low.	Increase air pressure or supply.
Low output on both strokes.	Closed or clogged valves.	Open valve or clear valve.
	Fluid supply is insufficient or exhausted.	Refill fluid. Prime system or flush it.
	Obstructions in fluid lines, hoses, valves, etc.	Follow pressure relief procedure, then clear obstruction.

7.0 TECHNICAL SPECIFICATIONS

Recommended application chart for IP05 series pump

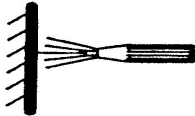
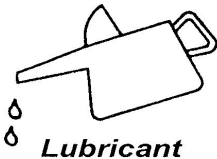
Industry	Application	Viscosity Range(CPS)
 Chemical	Alcohol	0-100
	Dye	0-1000
	Methyl Chloride	0-200
	Solvents	0-500
 Surface Finishing Material	Paint(Latex)	100-1000
	Paint(Oil base)	100-800
	Sealer(Wood)	100-800
	Stain(Oil base)	100-1000
 Lubricant	Anti-Freeze	30-100
	Die Lubricant	30-50
	Gear Oil	200-1000
	Lubricant	100-1500
	Mold Release Agent	30-100
	Oil	100-500

Operational specifications for IP05 series pump

Category	Data
Maximum fluid flow	3 GPM (11.4 Liters/min)
Maximum fluid working pressure	1800 psi (125bar)
Air input pressure range	40 – 180 psi (2 – 12.5 Bar)
Air inlet size	3/8" NPT (F)
Fluid inlet size	3/4" NPT (F)
Fluid outlet size	3/4" NPT (F)
Recommended cycle speed	15-25 cycles/min
Weight - IP05 Drum length/ Weight - IP05 Stubby length	31 lbs (14 Kg) 22 lbs (10 Kg)
Packings/seals	Teflon, UHMW PE
Rod and cylinder	304 stainless steel

Performance graphs for IP05 series pump

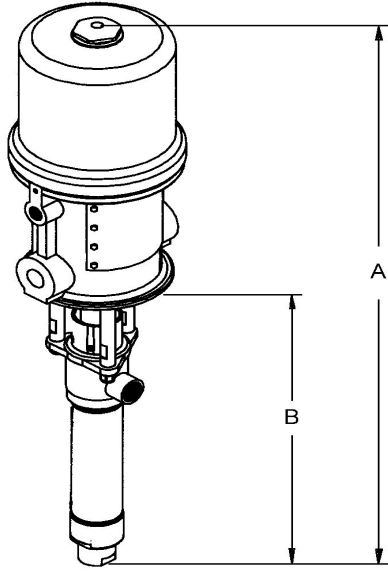

Model	A	B
IP05 Drum	54.75"	42.625"
IP05 Stubby	25.21"	13.75"

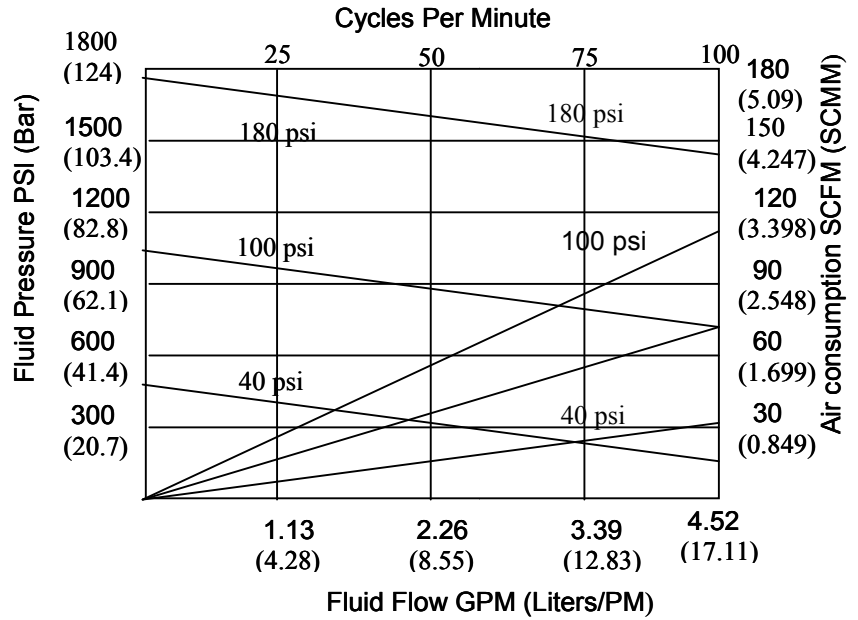

Mounting Hole Layout

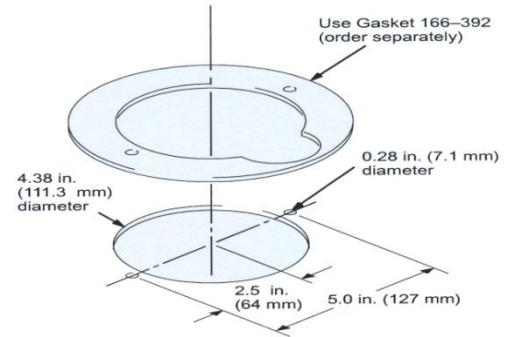

How to read performance graphs

Pressure/Flow

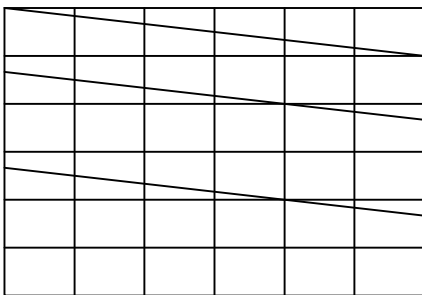

1. Locate required flow along bottom edge of chart.
2. Follow vertically to bold line for input air pressure.
3. Follow horizontally to left edge of chart to read maximum available fluid pressure.

Air consumption

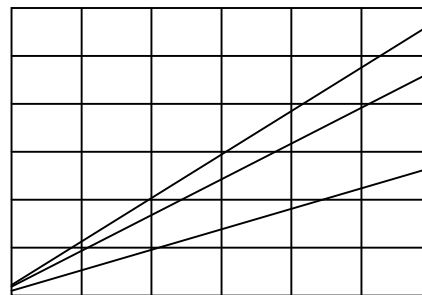

1. Locate fluid flow along bottom edge of chart.
2. Follow vertically to bold line for input air pressure.
3. Follow horizontally to right edge of chart to read air consumption.

Pump viscosity guide

All calculations in Centipoise (cps)

Air pressure requirements: For optimum pump performance, 40 – 100 PSI should be supplied to the IP05 series transfer pumps.

IP01 series pumps: 1 – 2,000 cps

IP02 series pumps: 1 – 4,000 cps

OP series pumps: 1 – 4,000 cps

IP05 series pumps: 1 – 10,000 cps

IP10 series pumps: 1 – 20,000 cps

IP15 series pumps: 1 – 20,000 cps

IP30 series pumps: 1 – 20,000 cps

Calculations are based on the following general guidelines

- Inbound air pressure: 100 psi
- Pressure at dispense point: 0 psi
- Hose/pipe length w/smooth inner surface = L: 25 feetxHose size = D: ¾"
- Flow rate = Q: 2 gpm
- Viscosity = V:
- Pressure loss in hose/pipe (psi), P: $P = 0.0273QVL/D^4$

The above viscosity values are only general guidelines. Other factors should always be taken into consideration such as; dispensing valves, fittings, hose unions, elevation, outside ambient temperature, etc.

8.0 WARRANTY & DISCLAIMERS

WARRANTY

International Pump Manufacturing, Inc. (hereafter designated IPM) warrants the equipment it manufactures to be free of defects in materials and workmanship for a period of one (1) year from the date of sale from IPM to an authorized IPM distributor or to the original end user and/or purchaser. IPM will, at its discretion, repair or replace any part of the equipment proven to be defective. This warranty applies only when the equipment is used for the intended purpose and has been installed, operated and maintained in accordance with written operating procedures.

A condition of the warranty is the prepaid return of the equipment to an authorized distributor of IPM who shall provide verification of the warranty claim. IPM will repair or replace free of charge any parts found and verified to be defective or damaged upon receipt of equipment. Shipping will be prepaid for the repaired or replaced parts under warranty. Should inspection of the equipment reveal no defects in material or workmanship repairs will be made at the standard IPM rate, which will include parts, inspection, labor, packaging and shipping.

The warranty does not apply nor shall IPM be liable for damage, operational wear, malfunction of equipment caused by improper installation, misuse, chemical abrasion or corrosion, operator negligence, accident, tampering or altering of equipment, lack of improper maintenance and/or by substitution of non-IPM parts. Additionally, IPM shall not be liable for nor does the warranty apply to operational wear, damage or malfunction caused by incompatibility of accessories, components, structures, equipment or materials not supplied by IPM. The warranty does not apply to nor will IPM be responsible for the improper operation, maintenance, design, manufacture, installation of components, accessories, equipment or structures not supplied by IPM.

The warranty is void unless the Warranty Registration Card is properly completed and returned to IPM within ONE (1) month of the date of the sale.

LIMITATIONS AND DISCLAIMERS

This warranty is the sole and exclusive remedy for the purchaser. No other warranties, expressed or implied, warranties for fitness of purpose or merchantability, or non-contractual liabilities are made by IPM, including product liability, whether on negligence or a strict liability basis. Liability for directly special or non-contractual damages or loss is expressly excluded and denied. IPM's liability shall in no case exceed the amount of the purchase price.

IPM does not warrant and disclaims implied warranties of merchantability and fitness for a particular purpose, components, accessories, equipment, materials sold but not manufactured by IPM. These parts (valves, hoses, fittings, etc.) are subject to the provisions within the warranty of the actual manufacturer of these items. IPM will provide reasonable assistance with warranty claims on these items.



**3107 142nd Avenue East Suite 106
Sumner, WA 98390
U.S.A.**

**TEL: (253) 863 2222 FAX: (253) 863 2223
Website : www.ipmpumps.com**

Updated May 2015